

Model Toilet/รุ่น	Seat/ฝาของนั่ง
K-8688X-S-**	K-18762X-**

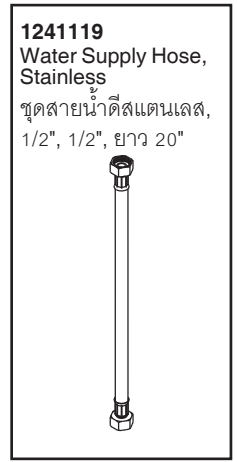
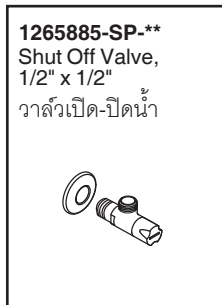
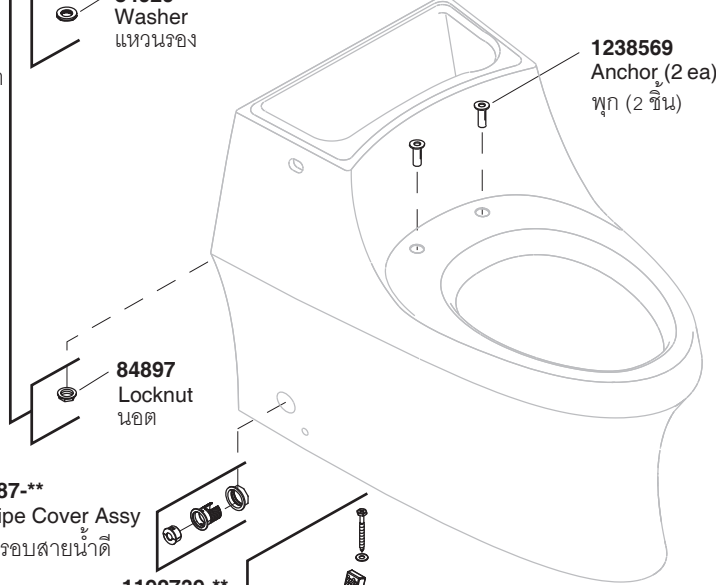
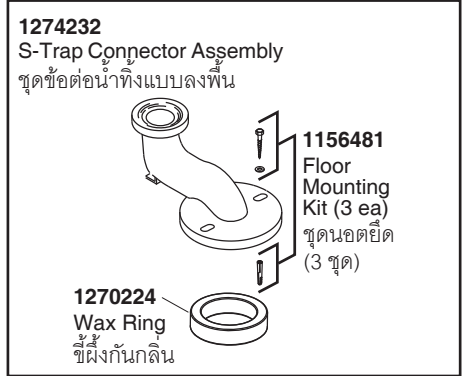
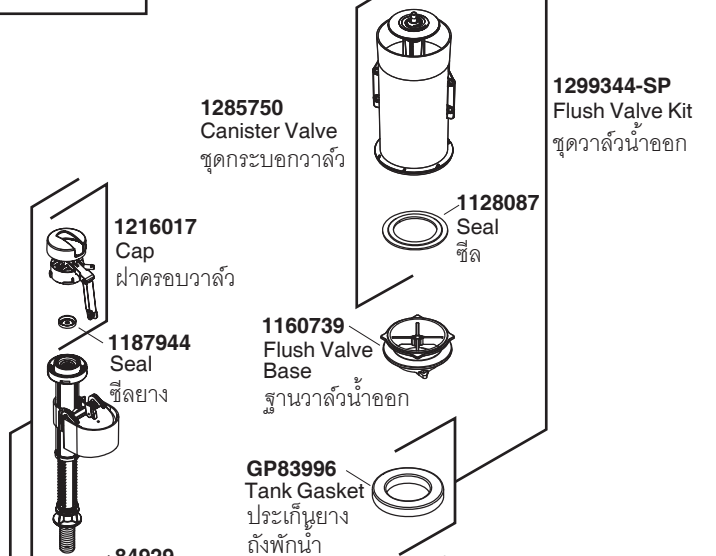
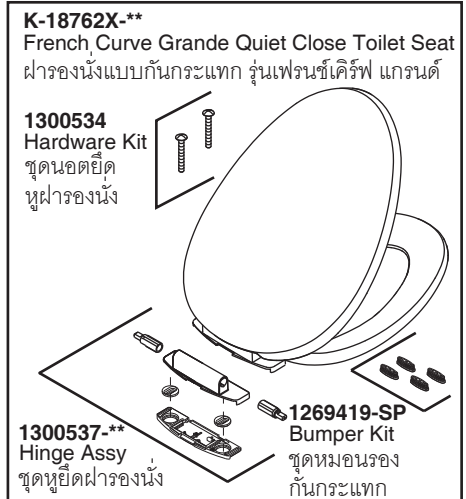
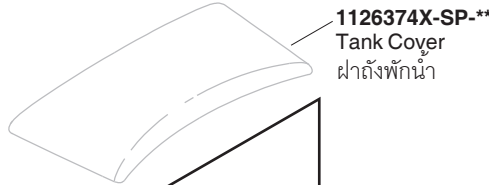

\*\*Finish/color code must be specified when ordering  
\*\*ระบุรหัสสี/สีเคลือบผิว/สีในการสั่งซื้อผลิตภัณฑ์